

(12) INTERNATIONAL APPLICATION PUBLISHED UNDER THE PATENT COOPERATION TREATY (PCT)

(19) World Intellectual Property Organization
International Bureau



(43) International Publication Date
22 August 2002 (22.08.2002)

PCT

(10) International Publication Number
WO 02/065667 A1

(51) International Patent Classification⁷: H04B 7/005

(21) International Application Number: PCT/US02/04725

(22) International Filing Date: 15 February 2002 (15.02.2002)

(25) Filing Language: English

(26) Publication Language: English

(30) Priority Data:
09/788,258 15 February 2001 (15.02.2001) US

(71) Applicant: QUALCOMM INCORPORATED [US/US];
5775 Morhouse Drive, San Diego, CA 92121 (US).

(72) Inventor: WILLENEGGER, Serge; Derrière-Ville B,
CH-1425 Onnens (CH).

(74) Agents: WADSWORTH, Philip, R. et al.; Qualcomm In-
corporated, 5775 Morehouse Drive, San Diego, CA 92121-
1714 (US).

(81) Designated States (national): AE, AG, AL, AM, AT, AU,
AZ, BA, BB, BG, BR, BY, BZ, CA, CH, CN, CO, CR, CU,

CZ, DE, DK, DM, DZ, EC, EE, ES, FI, GB, GD, GE, GH,
GM, HR, HU, ID, IL, IN, IS, JP, KE, KG, KP, KR, KZ, LC,
LK, LR, LS, LT, LU, LV, MA, MD, MG, MK, MN, MW,
MX, MZ, NO, NZ, OM, PH, PL, PT, RO, RU, SD, SE, SG,
SI, SK, SL, TJ, TM, TN, TR, TT, TZ, UA, UG, UZ, VN,
YU, ZA, ZM, ZW.

(84) Designated States (regional): ARIPO patent (GH, GM,
KE, LS, MW, MZ, SD, SL, SZ, TZ, UG, ZM, ZW),
Eurasian patent (AM, AZ, BY, KG, KZ, MD, RU, TJ, TM),
European patent (AT, BE, CH, CY, DE, DK, ES, FI, FR,
GB, GR, IE, IT, LU, MC, NL, PT, SE, TR), OAPI patent
(BF, BJ, CF, CG, CI, CM, GA, GN, GQ, GW, ML, MR,
NE, SN, TD, TG).

Published:
— with international search report
— before the expiration of the time limit for amending the
claims and to be republished in the event of receipt of
amendments

For two-letter codes and other abbreviations, refer to the "Guid-
ance Notes on Codes and Abbreviations" appearing at the begin-
ning of each regular issue of the PCT Gazette.

(54) Title: METHOD AND APPARATUS FOR CONTROLLING TRANSIT POWER OF MULTIPLE CHANNELS IN A CDMA COMMUNICATION SYSTEM

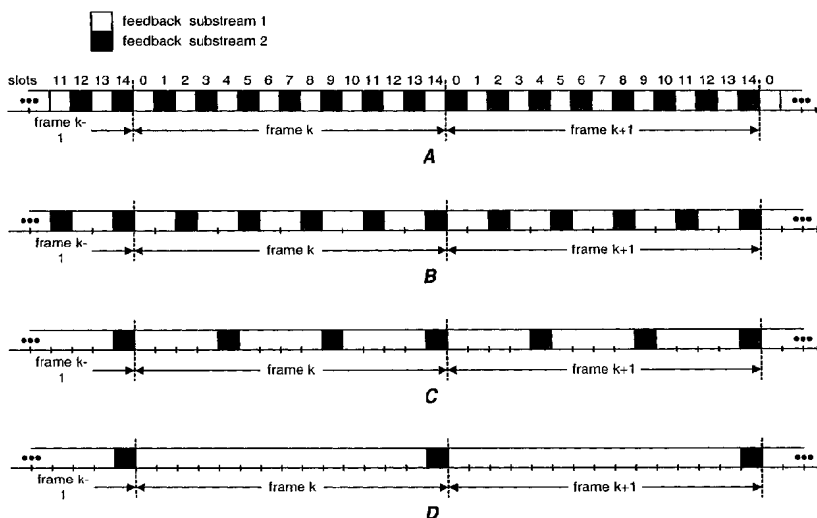

(57) **Abstract:** Techniques to support independent power control of multiple channels in CDMA systems (e.g., a W-CDMA system) that define a single power control feedback stream on the uplink, which is to be used for downlink power control. In one aspect, the single feedback stream is "time shared" among multiple channels requiring individual power control. Various time-sharing schemes may be used to implement multiple (substantially parallel) feedback substreams based on the single feedback stream, and different combination of feedback rates may also be achieved for the substreams. Each feedback substream may be assigned to, and used for power control of, a respective channel. In another aspect, multiple feedback substreams are implemented based on multiple fields in newly defined slot formats.



WO 02/065667 A1

METHOD AND APPARATUS FOR CONTROLLING TRANSMIT POWER OF MULTIPLE CHANNELS IN A CDMA COMMUNICATION SYSTEM

5

BACKGROUND OF THE INVENTION

I. Field of the Invention

10 The present invention relates to data communication. More particularly, the present invention relates to novel and improved techniques for controlling transmit power of multiple channels in a CDMA communication system (e.g., a W-CDMA system).

II. Description of the Related Art

15

In a wireless communication system, a user with a user terminal (e.g., a cellular phone) communicates with another user through transmissions on the downlink and uplink via one or more base stations. The downlink (i.e., forward link) refers to transmission from the base station to the user terminal, and the uplink (i.e., reverse link) refers to transmission from the user terminal to the base station. The downlink and uplink are typically allocated different frequencies.

20 In a Code Division Multiple Access (CDMA) system, the total transmit power from a base station is typically indicative of the total downlink capacity since data may be concurrently transmitted to a number of users over the same frequency band. A portion of the total transmit power is allocated to each active user such that the aggregate transmit power for all users is less than or equal to the total available transmit power.

30 To maximize the downlink capacity, the transmit power to each user terminal may be controlled by a power control loop such that the signal quality, as measured by the signal-to-noise-plus-interference ratio (SNR), of a transmission received at the user terminal is maintained at a target SNR. This target SNR is often referred to as the power control setpoint (or simply, the setpoint). A second power control loop is typically employed to adjust the setpoint such that a desired level of performance, as measured by a frame error rate (FER), is maintained. The downlink power control mechanism thus
35 attempts to reduce power consumption and interference while maintaining the

desired link performance. This results in increased system capacity and reduced delays in serving users.

Many newer generation CDMA systems support concurrently transmission on multiple channels to provide high-speed data service and/or multiple services (e.g., voice and packet data). These channels may be used to transmit data at different data rates, and may further utilize different processing schemes. A feedback stream (or power control subchannel) may be allocated to each user terminal for power control of these channels. The feedback stream is typically used to send information indicative of the received signal quality for the transmission on one of the channels. This information may then be used by the base station to provide power control for all channels.

The power control becomes more challenging if the transmit power for multiple channels is not related by a defined relationship. This can result if the channels are not transmitted from the same set of base stations (i.e., different "handover" situation). For example, a first channel may be transmitted from a set of base stations using soft handoff, and a second channel may be transmitted from only one base station in the set. For the first channel, the user terminal collects and combines the transmit power from all transmitting base stations to recover the transmission, and power control for this channel is based on the combined power. And for the second channel, the power control should be based on the transmit power received from the single transmitting base station.

From the perspective of the base station transmitting the second channel, the transmit power for the two channels may not be correlated. Typically, the percentage contribution from individual base stations is not known for a channel in soft handoff. Thus, the amount this base station contributes to the first channel may not be known. If a single feedback stream is allocated and used to send power control information for the first channel, effective power control of the second channel is typically not possible based on this feedback stream. If the transmit power for the two channels is not correlated, the base station is unable to accurately adjust the transmit power for the second channel based on feedback information for the first channel.

As can be seen, techniques that can be used to effectively control the transmit power of multiple channels, which may be transmitted from different sets of base stations, are highly desirable.

SUMMARY OF THE INVENTION

5 Various power control techniques are provided herein to support independent power control of multiple channels to achieve the desired level of performance while reducing interference and maximizing system capacity. These techniques may be advantageous applied in CDMA systems (e.g., a W-CDMA system) that define a single power control feedback stream on the uplink, which is used for downlink power control. The techniques described
10 herein can be used to implement multiple (substantially parallel) power control feedback substreams based on the single feedback stream. These feedback substreams may then be used to independently control the transmit power of channels assigned to the substreams.

In one aspect, the single feedback stream (e.g., as defined by the W-CDMA standard) is "time shared" among multiple channels requiring individual power control. Various time-sharing schemes may be used to implement multiple feedback substreams based on the single feedback stream, and different combination of feedback rates may also be achieved for the substreams. Each feedback substream may be assigned to, and used for power
15 control of, a respective channel.
20

In another aspect, multiple feedback substreams are implemented based on multiple fields in newly defined slot formats. Various schemes may be used to form the feedback substreams, and each feedback substream may be used for power control of a respective channel.

25 The invention further provides methods, power control units, and other elements that implement various aspects and features of the invention, as described in further detail below.

BRIEF DESCRIPTION OF THE DRAWINGS

30

The features, nature, and advantages of the present invention will become more apparent from the detailed description set forth below when taken in conjunction with the drawings in which like reference characters identify correspondingly throughout and wherein:

35 FIG. 1 is a diagram of a wireless communication system that supports a number of users;

FIGS. 2A and 2B are diagrams of the signal processing at a base station and a user terminal, respectively, for a downlink data transmission in accordance with the W-CDMA standard;

FIG. 3 is a diagram of a downlink power control mechanism capable of
5 implementing various aspects and embodiments of the invention;

FIG. 4 is a diagram of a frame format and a slot format for an uplink physical dedicated channel, as defined by the W-CDMA standard;

FIGS. 5A through 5D show the formation of two feedback substreams based on a single power control feedback stream, for four different feedback
10 rate combinations;

FIG. 6 is a timing diagram illustrating power control for multiple channels, in accordance with an embodiment of the invention; and

FIGS. 7 and 8 are block diagrams of an embodiment of the base station and the user terminal, respectively, which are capable of implementing various
15 aspects and embodiments of the invention.

DETAILED DESCRIPTION OF THE SPECIFIC EMBODIMENTS

FIG. 1 is a diagram of a wireless communication system 100 that
20 supports a number of users. System 100 provides communication for a number of cells, with each cell being serviced by a corresponding base station 104. Various user terminals 106 are dispersed throughout the system. Each user terminal 106 may communicate with one or more base stations 104 on the downlink and uplink at any particular moment, depending on whether or not
25 the user terminal is active and whether or not it is in soft handoff. As shown in FIG. 1, base station 104a communicates with user terminals 106a, 106b, 106c, and 106d, and base station 104b communicates with user terminals 106d, 106e, and 106f. User terminal 106d is in soft handoff and concurrently communicates with base stations 104a and 104b.

30 In system 100, a system controller 102 couples to base stations 104 and may further couple to a public switched telephone network (PSTN) and/or one or more packet data networks (PDN). System controller 102 provides coordination and control for the base stations coupled to it. System controller 102 further controls the routing of telephone calls among user terminals 106,
35 and between user terminals 106 and the users coupled to PSTN (e.g., conventional telephones), via base stations 104. System controller 102 is often

referred to as a base station controller (BSC) or a radio network controller (RNC).

System 100 may be designed to support one or more CDMA standards such as (1) the "TIA/EIA-95-B Mobile Station-Base Station Compatibility Standard for Dual-Mode Wideband Spread Spectrum Cellular System" (the IS-95 standard), (2) the "TIA/EIA-98-D Recommended Minimum Standard for Dual-Mode Wideband Spread Spectrum Cellular Mobile Station" (the IS-98 standard), (3) the standard offered by a consortium named "3rd Generation Partnership Project" (3GPP) and embodied in a set of documents including Document Nos. 3G TS 25.211, 3G TS 25.212, 3G TS 25.213, and 3G TS 25.214 (the W-CDMA standard), (4) the standard offered by a consortium named "3rd Generation Partnership Project 2" (3GPP2) and embodied in a set of documents including Document Nos. C.S0002-A, C.S0005-A, C.S0010-A, C.S0011-A, C.S0024, and C.S0026 (the cdma2000 standard), and (5) some other standards. These standards are incorporated herein by reference.

FIG. 2A is a diagram of the signal processing at base station 104 for a downlink data transmission, in accordance with the W-CDMA standard. The upper signaling layers of a W-CDMA system support concurrent transmission of a number of "transport" channels, with each transport channel capable of carrying data for a particular communication (e.g., voice, video, data, and so on). The data for each transport channel is provided, in blocks that are also referred to as transport blocks, to a respective transport channel processing section 210.

Within transport channel processing section 210, each transport block is used to calculate cyclic redundancy check (CRC) bits, in block 212. The CRC bits are attached to the transport block and used at the user terminal for error detection. A number of CRC coded blocks are then serially concatenated together, in block 214. If the total number of bits after concatenation is greater than the maximum size of a code block, the bits are segmented into a number of (equal-sized) code blocks. Each code block is then coded with a particular coding scheme (e.g., a convolutional code, a Turbo code) or not coded at all, in block 216, to generate coded bits.

Rate matching is then performed on the coded bits in accordance with a rate-matching attribute assigned by higher signaling layers, in block 218. On the uplink, bits are repeated or punctured (i.e., deleted) such that the number of bits to be transmitted matches the number of available bit positions. On the downlink, unused bit positions are filled with discontinuous transmission

(DTX) bits, in block 220. The DTX bits indicate when a transmission should be turned off and are not actually transmitted.

The bits are then interleaved in accordance with a particular interleaving scheme to provide time diversity, in block 222. In accordance with the W-
5 CDMA standard, the time interval over which interleaving is performed can be selected from a set of possible time intervals (i.e., 10 msec, 20 msec, 40 msec, or 80 msec). When the selected interleaving interval is longer than 10 msec, the bits within the interval are segmented and mapped onto consecutive transport channel radio frames, in block 224. Each transport channel radio frame
10 corresponds to a transmission over a (10 msec) radio frame period.

The radio frames from all active transport channel processing sections
210 are then serially multiplexed into a coded composite transport channel (CCTrCH), in block 232. DTX bits may then be inserted to the multiplexed radio frames such that the number of bits to be transmitted matches the number
15 of available bit positions on the "physical" channel(s) used for the data transmission, in block 234. If more than one physical channel is used, the bits are segmented among the physical channels, in block 236. The bits in each radio frame period for each physical channel are then interleaved to provide additional time diversity, at block 238. The interleaved physical channel radio
20 frames are then mapped to their respective physical channels, at block 240. Each physical channel may be used to transmit a particular transmission for a particular data type, as described below. The subsequent signal processing to generate a modulated signal suitable for transmission to the user terminal is known in the art and not described herein.

25 FIG. 2B is a diagram of the signal processing at user terminal 106 for a downlink data transmission, in accordance with the W-CDMA standard. The signal processing shown in FIG. 2B is complementary to that shown in FIG. 2A. Initially, the modulated signal is received, conditioned, digitized, and processed to provide symbols for each physical channel used for the data
30 transmission. Each symbol has a particular resolution (e.g., 4-bit) and corresponds to a transmitted bit. The symbols in each radio frame period for each physical channel are de-interleaved, in block 252, and the de-interleaved symbols from all physical channels are concatenated, in block 254. For a downlink transmission, non-transmitted bits are detected and removed, in
35 block 256. The symbols are then demultiplexed into various transport channels, in block 258. The radio frames for each transport channel are then provided to a respective transport channel processing section 260.

Within transport channel processing section 260, the transport channel radio frames are concatenated into "traffics", in block 262. Each traffic includes one or more transport channel radio frames and corresponds to the selected interleaving interval used at the transmitter unit. The symbols within each traffic are de-interleaved, in block 264, and non-transmitted symbols are removed, in block 266. Inverse rate matching is then performed to accumulate repeated symbols and insert "erasures" for punctured symbols, in block 268. Each coded block in the traffic is then decoded, in block 270, and the decoded blocks are concatenated and segmented into their respective transport blocks, in block 272. Each transport block is then checked for error using the CRC bits, in block 274.

The W-CDMA standard defines a channel structure capable of supporting a number of users and designed for efficient transmission of voice and packet data. In accordance with the W-CDMA standard, data to be transmitted is processed as one or more transport channels at a higher signaling layer. The transport channels support concurrent transmission of different types of services (e.g., voice, video, data, and so on). The transport channels are then mapped to physical channels that are assigned to a user terminal for a communication (e.g., a call).

For each communication in a W-CDMA system, a downlink dedicated physical channel (downlink DPCH) is typically assigned to the user terminal for the duration of the communication. The DPCH is used to carry a downlink transport channel characterized by the possibility of fast data rate change (e.g., every 10 msec), fast power control, and inherent addressing to specific user terminal.

If additional transmission capability is needed, a physical downlink shared channel (PDSCH) may also be assigned to the user terminal. For example, the PDSCH may be assigned for high rate packet data transmission. The PDSCH is used to carry a downlink transport channel shared by user terminals based on code multiplexing. The PDSCH is associated with the downlink DPCH. However, the PDSCH and DPCH do not need to have the same spreading factor (i.e., orthogonal code, which determines the data rate), and the spreading factor for the PDSCH may also vary from frame-to-frame.

The downlink DPCH is used to transmit user-dedicated data in a time-division multiplexed manner with control data (e.g., pilot, power control information, and so on). The downlink DPCH may thus be viewed as a

multiplex of a downlink dedicated physical data channel (DPDCH) and a downlink dedicated physical control channel (DPCCH).

On the downlink, the capacity of each base station is limited by its total transmit power. To provide the desired level of performance and increase system capacity, the transmit power of each transmission from the base station may be controlled to be as low as possible to reduce power consumption while maintaining the desired level of performance. If the received signal quality at the user terminal is too poor, the likelihood of correctly decoding the transmission decreases, and performance may be compromised (e.g., a higher FER). Conversely, if the received signal quality is too high, the transmit power level is also likely to be too high, and excessive amount of transmit power may have been unnecessarily used for the transmission, which reduces system capacity and may further cause extra interference to transmissions from other base stations.

FIG. 3 is a diagram of a downlink power control mechanism 300 capable of implementing various aspects and embodiments of the invention. Power control mechanism 300 includes an inner loop power control 310 that operates in conjunction with an outer loop power control 320.

Inner loop 310 is a (relatively) fast loop that attempts to maintain the signal quality of a transmission received at the user terminal as close as possible to a target signal-to-noise-plus-interference ratio (SNR). As shown in FIG. 3, inner loop 310 operates between the user terminal and base station, and one inner loop is typically maintained for each channel to be independently power controlled.

The inner loop power adjustment for a particular channel is typically achieved by (1) measuring the signal quality of the transmission on the channel at the user terminal (block 312), (2) comparing the received signal quality against the channel's setpoint (block 314), and (3) sending power control information back to the transmitting base station. The signal quality measurement may be made on the channel to be power controlled, a reference channel associated with the channel to be power controlled, or any other channel for which a relationship can be established with the channel to be power controlled. The power control information may be used by the transmitting base station to adjust its transmit power, and may be in the form of, for example, an "UP" command to request an increase in the transmit power or a "DOWN" command to request a decrease in the transmit power. The base station may adjust the transmit power for the channel accordingly (block 316)

each time it receives the power control information. For the W-CDMA system, the power control information may be sent as often as 1500 times per second, thus providing a relatively fast response time for inner loop 310.

5 Due to path loss in the communication link (cloud 318) that typically varies over time, especially for a mobile user terminal, the received signal quality at the user terminal continually fluctuates. Inner loop 310 thus attempts to maintain the received signal quality at or near the setpoint in the presence of changes in the communication link.

10 Outer loop 320 is a (relatively) slower loop that continually adjusts the setpoint such that a particular level of performance is achieved for the transmission to the user terminal. The desired level of performance is typically a target frame error rate (FER), which is 1% for some transmissions. Some other target values and/or performance criteria may also be used to adjust the setpoint.

15 The outer loop setpoint adjustment for a particular channel is typically achieved by (1) receiving and processing the transmission on the channel to recover transmitted frames, (2) determining the status of each received frame (block 322) as being decoded correctly (good) or in error (erased), and (3) adjusting the setpoint (block 324) based on the frame status (and possibly along
20 with other information). If a frame is decoded correctly, the received signal quality at the user terminal is likely to be higher than necessary. The setpoint may then be reduced slightly, which may cause inner loop 310 to reduce the transmit power for the transmission. Alternatively, if a frame is decoded in error, the received signal quality at the user terminal is likely to be lower than
25 necessary. The setpoint may then be increased, which may cause inner loop 310 to increase the transmit power for the transmission.

By controlling the manner in which the channel's setpoint is adjusted, different power control characteristics and performance level may be obtained. For example, the target FER may be adjusted by changing the amount of
30 upward adjustment in the setpoint for a bad frame, the amount of downward adjustment for a good frame, the required elapsed time between successive increases in the setpoint, and so on. The target FER (i.e., the long-term FER) may be set as $\Delta D / (\Delta D + \Delta U)$, where ΔU is the amount of increase in the setpoint for an erased frame, and ΔD is the amount of decrease in the setpoint for a good
35 frame. The absolute sizes for ΔU and ΔD determine the responsiveness of the system to sudden changes in the communication link.

For the W-CDMA system, the user terminal estimates the SNR of the transmission on the DPCCH/DPDCH (i.e., the downlink DPCH). The user terminal then compares the estimated SNR to the target SNR and generates transmit power control (TPC) commands to increase or decrease the transmit power if the estimated SNR is respectively less than or greater than the target SNR. In response to receiving the TCP command, the base station may adjust the transmit power of the DPCCH/DPDCH.

The ratio of the transmit power for different downlink channels to the same user terminal is not specified in the W-CDMA system and may change with time. In a common operating scenario, the PDSCH and downlink DPCH are transmitted from one base station. In this case, the transmit power of the PDSCH may be controlled based on the TPC commands generated for the downlink DPCH (i.e., based on the inner power control loop maintained for the downlink DPCH). The base station has knowledge of the processing performed for the PDSCH and downlink DPCH, and is able to determine the target SNR for each of these channels. The base station is also able to scale the transmit power for these channels accordingly to achieve the target SNR.

Power control of the PDSCH and downlink DPCH based on the same TPC commands works well when both channels are transmitted from the same set of base stations (e.g., from one base station). However, this scheme is typically not appropriate for soft handoff scenarios. The W-CDMA standard allows for operation of the downlink DPCH in soft handoff, but presently does not allow for operation of the PDSCH in soft handoff. The PDSCH and its associated downlink DPCH may therefore be operated in different handoff modes.

If the downlink DPCH is in soft handoff, the user terminal collects and combines the transmit power from a set of base stations to recover the transmission on the DPCH. The power control for the DPCH is then based on the total power for the DPCH received from all transmitting base stations. The specific percentage contribution from individual base stations may not be known to the system controller. Thus, if one of the base stations in the set also transmits the PDSCH, the amount of transmit power to be used for the PDSCH is not correlated to, or determinable from, its transmit power for the PDCH. The transmit power for the PDSCH may be incorrectly controlled if based on the TPC commands received for the DPCH, and adjustment of the PDSCH transmit power based on these TPC commands would likely result in random allocation of PDSCH transmit power (relative to the actual required allocation).

This random allocation would be detrimental to the link quality and system capacity, and is therefore highly undesirable.

Several simple schemes may be used to control the PDSCH transmit power if it is not correlated to the DPCH transmit power. In one scheme, the PDSCH transmit power is boosted to a sufficient level to ensure correct
5 reception. However, this would require the PDSCH to be transmitted at a high power level to safeguard against worse case path loss and operating scenarios. In another simple scheme, a fixed power allocation is used for the PDSCH. However, performance would likely suffer as channel condition changes. In
10 yet another simple scheme, messaging is used to control the PDSCH transmit power (e.g., using the frame erasure information transmitted on the uplink). However, this power control mechanism is slow and may not adequately adapt to changing link conditions, which may again result in performance degradation. These simple schemes are thus not effective for power control of
15 multiple channels.

As noted above, the PDSCH is typically used for high rate packet data transmissions, and the average transmit fraction required to provide the desired quality of service may represent a non-negligible fraction of the total transmit power from the base station. For example, the average power fraction
20 requirement for high rate channels may be 13 dB (5% of the total base station transmit power) or more.

For the PDSCH and downlink DPCH, a fast power control loop (i.e., the inner loop) may be used to adjust the transmit power of each of these channels inversely with respect to the link condition (i.e., more transmit power if the link
25 worsens). This ensures that the received signal quality at the base station is maintained at or near the target SNR. The fast power control loop allows for quick adjustment of the transmit power to track rapidly changing link conditions.

Lower power control rates may be sufficient for certain high rate
30 channels. The dynamic range of single path Rayleigh fading is in the order of 10 to 20 dB. If the average power fraction requirement is 13 dB or more, the base station is typically not able to compensate for such a wide range of fading since it would either run out of power or would need to drop other users to provide the required transmit power. Thus, for high rate channels such as the
35 PDSCH, it may not be essential to send power control commands at a high rate since in many instances the base station would not have the power resources available to implement the commands.

Various power control techniques are provided herein to support independent power control of multiple channels to achieve the desired level of performance while reducing interference and maximizing system capacity. These techniques may be advantageously applied in CDMA systems (e.g., the W-
5 CDMA system) that define a single power control feedback stream on the uplink, which is used for downlink power control. The techniques described herein can be used to implement multiple (substantially parallel) power control feedback substreams based on the single power control feedback stream. These feedback substreams may then be used to independently control the transmit
10 power of channels assigned to the substreams.

In accordance with one aspect, the single power control feedback stream (e.g., as defined by the W-CDMA standard) is "time shared" among multiple channels requiring individual power control. Various time-sharing schemes may be used to implement multiple feedback substreams based on the single
15 feedback stream, as described below. Each feedback substream may then be assigned to, and used for power control of, a respective channel.

In accordance with another aspect, multiple feedback substreams are implemented based on multiple fields in newly defined slot formats. Various schemes may be used to form the feedback substreams, and each feedback
20 substream may be used for power control of a respective channel, as described below.

The power control techniques described herein can be used for various wireless communication systems, and may be advantageously employed for the downlink and/or uplink. For example, the power control techniques
25 described herein may be used for CDMA systems that conform to the W-CDMA standard, the cdma2000 standard, some other standard, or a combination thereof. For clarity, various aspects and embodiments of the invention are described below for a specific implementation on the downlink of a W-CDMA system.

30 FIG. 4 is a diagram of a frame format and a slot format for the DPDCH and DPCCH of the uplink DPCH, as defined by the W-CDMA standard. The DPDCH carries user-dedicated packet data, and the DPCCH carries control data (including power control information for the downlink channels). On the uplink, the DPDCH and DPCCH are respectively transmitted on the inphase (I)
35 and quadrature (Q) components of a modulated uplink signal. The transmissions on the DPDCH and DPCCH are partitioned into radio frames, with each radio frame covering 15 slots labeled as slot 0 through slot 14. For

the DPCCH, each slot is further partitioned into a number of fields used to carry different types of control data.

As shown in FIG. 4, the DPDCH includes a data field 420 used to send data from the user terminal. The DPCCH includes a pilot field 422, a transport format combination indicator (TFCI) field 424, a feedback information (FBI) field 426, and a transmit power control (TPC) field 428. Pilot field 422 is used to send a pilot for the dedicated physical channel. TFCI field 424 is used to send instantaneous parameters (e.g., the bit rate, channelization code, and so on) of the transport channels multiplexed on the uplink DPDCH. FBI field 426 is used to support techniques requiring feedback between the user terminal and base station, such as various transmit diversity modes. And TPC field 428 is used to send power control information to direct the base station to adjust its transmit power on the downlink channels either up or down to achieve the desired performance while minimizing interference.

In accordance with an aspect of the invention, multiple parallel power control feedback substreams are implemented by time-sharing a single power control feedback stream. As defined by the W-CDMA standard, each frame has a duration of 10 msec, and each slot has a duration of 1.67 msec. The slot rate is thus 1500 slots/sec. As shown in FIG. 4, each slot includes TPC field 428 for reporting power control information. If a TPC command is sent once each slot, the feedback stream has a rate of 1500 commands/sec (i.e., 1500 cps). The 1500 cps may be used to implement multiple feedback substreams in a time-shared manner, as described below.

FIGS. 5A through 5D are diagrams illustrating four different time-shared formats for providing multiple feedback substreams based on the single feedback stream, in accordance with certain embodiments of the invention. In FIG. 5A, two feedback substreams are supported based on the single feedback stream, with the commands for the two substreams being transmitted on alternate slots. As shown in FIG. 5A, the commands for the first feedback substream are transmitted in slots 0, 2, 4, ... and 14 of frame k, and slots 1, 3, 5, ... and 15 of frame k+1. The commands for the second feedback substream are transmitted in slots 1, 3, 5, ... and 15 of frame k and slots 0, 2, 4, ... and 14 of frame k+1. If the feedback stream has a rate of 1500 cps, then each feedback substream has a rate of 750 cps.

In FIG. 5B, the two feedback substreams are assigned to slots in a manner to provide feedback rates of 1000 cps and 500 cps for the first and second substreams, respectively. This is achieved by transmitting two

commands in two consecutive slots for the first substream, followed by a single command in one slot for the second substream, and repeating the pattern.

In FIG. 5C, the two feedback substreams are assigned to slots in a manner to provide feedback rates of 1200 cps and 300 cps for the first and second substreams, respectively. This is achieved by transmitting four commands in four consecutive slots for the first substream, followed by a single command in one slot for the second substream, and repeating the pattern.

And in FIG. 5D, the two feedback substreams are assigned to slots in a manner to provide feedback rates of 1400 cps and 100 cps for the first and second substreams, respectively. This is achieved by transmitting 14 commands in 14 slots for the first substream and a single command in one slot for the second substream.

Based on the above, it can be observed that two parallel feedback substreams of various combinations of rates may be supported by properly assigning the slots to the substreams. FIGS. 5A-5D also show the use of repeating slot assignment patterns for the two substreams, with the patterns being periodic within one or two frames. In particular, FIG. 5A uses a "1-1" pattern for 750/750 feedback rates, FIG. 5B uses a "2-1" pattern for 1000/500 feedback rates, FIG. 5C uses a "4-1" pattern for 1200/300 feedback rates, and FIG. 5D uses a "14-1" pattern for 1400/100 feedback rates. The slot assignment patterns of "1-1", "2-1", and "4-1" are replicated as many times as needed for each frame.

Other feedback rates may also be supported by use of other slot assignment patterns that may be periodic over multiple frames (i.e., similar to the "1-1" pattern, which is periodic over two frames). For example, feedback rates of 1125 cps and 375 cps for the first and second substreams, respectively, may be achieved by transmitting three commands in three consecutive slots for the first substream, followed by a single command in one slot for the second substream, and repeating the pattern. Alternatively, non-periodic patterns may also be used to form the feedback substreams.

FIGS. 5A through 5D show the formation of two feedback substreams based on the single feedback stream. In general, any number of feedback substreams may be formed by properly assigning the slots. For example, three feedback substreams of 500/500/500 cps may be supported by using a "1-1-1" pattern, whereby a single command for each of the first, second, and third substreams is transmitted in every third slot. Each of the substreams may then be assigned to, and used for sending power control information for, a

respective channel. Again, any number of substreams and any combination of feedback rates may be supported, so long as the aggregate rate of the substreams is equal to or less than the rate of the feedback stream. The substreams may have the same or different feedback rates, as illustrated above.

5 The feedback substreams may be defined (i.e., assigned with slots) based on various schemes. In one scheme, the substreams are defined *a priori*. Different time-shared formats may be used to define the feedback substreams, such as the ones shown above for FIGS. 5A-5D. The user terminal is informed, or otherwise made aware, of the particular time-shared format to use for a
10 communication with the base station. For example, the user terminal may know to use the 1000/500 cps feedback substreams when the PDSCH and downlink DPCH are both in use and in a different handover situation (i.e., the PDSCH and DPCH are transmitted from different sets of cells). If the handover situation is the same (e.g. no handover, or handover with the same cell set),
15 there is typically no need to differentiate the feedback substreams. However, multiple feedback substreams may still be used for any number of reasons such as, for example, to obviate the need to change the uplink configuration each time the downlink configuration is changed.

In another scheme, the feedback substreams may be defined based on
20 negotiation between the base station and user terminal (e.g., at the start of a communication, or as channels are added or removed during the communication). This scheme provides flexibility in forming feedback substreams. The substreams may be defined based on the performance level to be achieved, the link conditions, and other factors.

25 The feedback substreams may be assigned to the channels in any desired manner. In one implementation, the feedback substream with the lower rate is assigned and used for power control of the PDSCH, and the higher rate feedback substream is used for power control of the downlink DPCH. This may ensure less performance degradation for the downlink DPCH, which
30 carries important control (e.g., the TFCI) and signaling messages used to control both the DPCH and PDSCH.

The multiplexing of power control information (e.g., TPC commands) for the two feedback substreams into the available slots for the feedback stream effectively reduces the feedback rates (e.g., to 750/750 cps) for the downlink
35 DPCH and PDSCH. Based on earlier studies performed for IS-95 systems, the reduction in feedback rate has minimal impact on performance when the user terminal is moving at lower or higher speeds where the link variation is

respectively slow and easy to track (e.g., even for 750 cps) or too rapid and difficult to correct. (If the fading is too fast at high velocities, even 1500 cps power control may be insufficient, in which case the channel interleavers average out the effect of fading.) The reduced feedback rate would most likely
5 affect performance if the user terminal is moving at mid-range speeds (e.g., 30-60 km/hr). At these speeds, prior studies indicate that the impact on performance can be expected to be in the order of 0.5 dB or less in many instances.

Since fast power control of the PDSCH may not be possible or practical
10 in certain scenarios (e.g., when the PDSCH is used for high rate packet data transmission), a lower feedback rate may be sufficient for this channel. For example, a feedback rate of 500, 300, or 100 cps may provide good performance for the PDSCH while reducing the feedback rate for the DPCH by an acceptable amount. If the feedback rate for the PDSCH is 500 cps or less, the feedback rate
15 for the DPCH is still relatively high at 1000 cps or more. This allows the DPCH to be power controlled at a relatively high rate, which may reduce performance degradation to few tenths of a dB in the mid-range speeds. Again, the lower feedback rate for the PDSCH may provide the requisite level of performance and may be sufficient, especially if the base station is not able to apply
20 commands at faster rate due to other considerations and/or limitations.

For the feedback substreams implemented based on time-sharing of the single feedback stream, the same defined slot format may be used for the substreams. TPC commands for the feedback substreams may be generated and transmitted in the TPC field in similar manner as that used for the feedback
25 stream. However, both the user terminal and base station know which command belongs to which substreams, and are able to respectively generate and process the commands.

In accordance with another aspect of the invention, multiple parallel feedback substreams are implemented by defining multiple TPC fields in a slot.
30 One or more TPC fields may be defined in addition to the original TPC field for the power control feedback stream. Each TPC field may then be assigned to a respective channel.

The W-CDMA standard defines a number of slot formats that may be used for the uplink DPCCCH. Each slot format allocates a specific number of
35 bits to each of the control fields in the uplink DPCCCH shown in FIG. 4. The particular slot format to be used for a communication is typically negotiated at the start of the communication and used for the duration of the communication.

The slot format may also be changed during a communication through channel reconfiguration (via signaling). For certain designs, the user terminal may also be able to autonomously change the slot format, e.g., in case of new handover situation for power controlled channels. New slot format may also be explicitly selected by a network and conveyed together with, or possibly within, a handover message. For the slot formats defined by the W-CDMA standard, the bits in the TPC field for each slot are intended to be used for transmission of a TPC command for DPCH/ PDSCH power control.

Table 1 lists slot formats 0 through 5B defined by the W-CDMA standard (version V3.1.1) for the uplink DPCH. Each slot for the uplink DPCH includes a number of fields, as shown in FIG. 4. Each slot format in Table 1 defines the length (in number of bits) of each field in the slot. As shown in Table 1, one or more of the fields may be omitted (i.e., length = 0) for some of the slot formats.

15

Table 1

Slot Format	Bits/Slot				
	N_{Pilot}	N_{TPC1}	N_{TPC2}	N_{TFCI}	N_{FBI}
0	6	2	0	2	0
0A	5	2	0	3	0
0B	4	2	0	4	0
1	8	2	0	0	0
2	5	2	0	2	1
2A	4	2	0	3	1
2B	3	2	0	4	1
3	7	2	0	0	1
4	6	2	0	0	2
5	5	1	0	2	2
5A	4	1	0	3	2
5B	3	1	0	4	2
6 [1]	6 [8]	2	2	0	0
7 [0]	4 [6]	2	2	2	0
7A [0B]	4 [4]	1	1	4	0
7B [0B]	2 [4]	2	2	4	0
8 [4]	4 [6]	2	2	0	2
9 [5]	2 [5]	2	2	2	2
9A [5B]	2 [3]	1	1	4	2

In accordance with specific embodiments of the invention, new slot formats 6 through 9A in Table 1 are defined to support two feedback

substreams. Slot format 6 is based on slot format 1 (as indicated by the [1] in column 1), slot format 7 is based on slot format 0, slot formats 7A and 7B are based on slot format 0B, slot format 8 is based on slot format 4, slot format 9 is based on slot format 5, and slot format 9A is based on slot format 5B. In an
5 embodiment, the new slot formats retain the TFCI and FBI fields of the corresponding "base" slot formats.

For each new slot format, two TPC fields are defined using bits in the TPC field of the base slot format and zero or more pilot bits. For new slot formats 6, 7, 7B, 8, and 9A, the TPC2 field is defined using only bits taken from
10 the pilot field. The number of pilot bits (as indicated within the bracket in column 2) in the base slot format is thus reduced. For example, for slot format 6, the TPC2 field for feedback substream 2 is defined using two pilot bits, thus reducing the number of pilot bits from 8 (for base slot format 1) down to 6. For new slot format 7A, the two bits in the original TPC field are allocated one
15 apiece to the TPC1 and TPC2 fields.

For the new slot formats shown in Table 1, the two TPC fields include the same number of bits. Also, since the two TPC fields are included in each slot, the feedback rate is 1500 cps. The TPC fields may also be defined with
20 different number of bits. Moreover, different bit rates may also be obtained by sending a TPC command over multiple slots. This may reduce the number of pilots bits needed to be taken to implement the second feedback substream. For example, another slot format may be defined based on slot format 6, with the TPC1 field including two bits, the TPC2 field including one bit, and the pilot field including seven bits. The TPC command for the second substream
25 may then be transmitted over two slots to achieve a feedback rate of 750 cps.

Table 1 shows the formation of two TPC fields for two feedback substreams. In general, any number of TPC fields may be defined in a slot. Each TPC field may be assigned for power control of a respective channel.

Defining new slot formats that are additions to existing defined slot
30 formats allow the user terminal and base station to utilize the existing slot formats, which are still valid for many operating scenarios. The new slots format may be selected for use whenever appropriate (e.g., if the PDSCH is assigned during a communication).

If pilot bits are taken to implement the second feedback substream, as for
35 many of the new slot formats listed in Table 1, the pilot power is reduced correspondingly. The user terminal may increase the DPCCH transmit power to allow for proper tracking and demodulation at the base station. If equivalent

pilot energy is needed at the base station to achieve similar performance, the DPCCH transmit power may be increased by approximately 1.25 dB (i.e., $10 \log(8/6) = 1.25$ dB) for slot format 6 and approximately 3 dB for slot format 9A, in comparison to the DPCCH transmit power for the corresponding base slot formats 1 and 5B. This increase in DPCCH transmit power is independent of the environment.

The techniques described above may also be used in combination to implement multiple parallel feedback substreams. For example, 1500/750 feedback substreams may be implemented by transmitting the first feedback substream on every slot, and transmitting the second feedback substream along with the first feedback substream on every other slot (e.g., using one of the new slot formats). As another example, 1500/750/750 feedback substreams may be implemented by assigning the first feedback substream to TPC1 on every slot, the second feedback substream to TPC2 on every other slot, and the third feedback substream to TPC2 on alternate slots.

Each feedback substream may be used to transmit any type of information that may be used for power control of the associated channel. The information transmitted on each feedback substream may be, for example, TPC commands, erasure indicator bits (EIBs) or frame status, quality indicator bits (QIBs), SNR estimates, data rate control (DRC) commands, or some other information. The TPC commands, EIBs, and QIBs are typically binary values whereas the SNR estimates and DRC commands may be multi-bit values.

A TPC command requests the base station to adjust the transmit power for the associated channel either up or down by a particular amount (e.g., 0.5 or 1 dB) to allow the user terminal to achieve the target SNR. An EIB indicates whether a frame was received correctly (good) or in error (erased). A QIB indicates whether the current transmit power level is inadequate or adequate. QIB is typically generated based on FER statistic collection whereas TPC is typically generated based on SNR measurements. The base station may elect to implement or ignore each of the received TPC commands, EIBs, or QIBs.

The SNR for a received transmission, as estimated at the user terminal, may also be reported to the base station. The SNR estimates may be quantized to any number of bits, depending on the specific implementation. The estimated SNR may also be translated into a particular data rate supported by a particular transmit power level for a packet data transmission. A DRC command indicative of the supported data rate may be reported and use for power control. A multi-bit feedback may be used to adjust the transmit power

or data rate for the transmission on the associated channel in finer granularity than possible with a binary feedback, which may improve performance and capacity. The types of information that may be reported back for power control are described in further detail in U.S. Patent Application Serial No. 09/755,659, 5 entitled "METHOD AND APPARATUS FOR POWER CONTROL OF MULTIPLE CHANNELS IN A WIRELESS COMMUNICATION SYSTEM," filed January 5, 2001, assigned to the assignee of the present application and incorporated herein by reference.

Techniques to derive the information that may be reported back for 10 power control are described in further detail in U.S. Patent No. 6,097,972, entitled "METHOD AND APPARATUS FOR PROCESSING POWER CONTROL SIGNALS IN CDMA MOBILE TELEPHONE SYSTEM," issued August 1, 2000, U.S. Patent No. 5,903,554, entitled "METHOD AND APPARATUS FOR MEASURING LINK QUALITY IN A SPREAD SPECTRUM 15 COMMUNICATION SYSTEM," issued May 11, 1999, and U.S. Patent Nos. 5,056,109, and 5,265,119, both entitled "METHOD AND APPARATUS FOR CONTROLLING TRANSMISSION POWER IN A CDMA CELLULAR MOBILE TELEPHONE SYSTEM," respectively issued October 8, 1991 and November 23, 1993, all assigned to the assignee of the present application and incorporated 20 herein by reference.

FIG. 6 is a timing diagram illustrating power control for multiple channels, in accordance with an embodiment of the invention. At the top of FIG. 6, a base station transmits on the downlink PDSCH and DPCCH. The start of the DPCH frame may be denoted as T_{DPCH} , and the start of the PDSCH frame 25 may be denoted as T_{PDSCH} . In accordance with the W-CDMA standard, each PDSCH frame is associated with one DPCH frame and has the timing relationship $\{-35840 < (T_{DPCH} - T_{PDSCH}) < 2560 \text{ chips}\}$ (i.e., the PDSCH frame starts anywhere between 1 slot before and up to 14 slots behind the start of the associated DPCH frame. The time offset between the start of the slots for the 30 PDSCH and DPCCH is designated as T_{OS} in FIG. 6. Due to propagation delay, T_{PD} , the transmissions on the PDSCH and DPCCH are received a short time later at the user terminal.

For power control of the downlink DPCH, the user terminal estimates the SNR of the pilot in slot $i-1$ of the downlink DPCCH, determines the TPC 35 command corresponding to the estimated SNR, and sends the TPC command in the TPC1 field in slot $i-1$ of the uplink DPCCH. In accordance with the W-CDMA standard, the frame timing on the uplink DPCH is delayed by 1024

chips from that of the corresponding downlink DPCH, as measured at the user terminal's antenna. After the propagation delay, T_{pd} , the base station receives the uplink DPCCH, determines the TPC command in the TPC1 field of slot i-1, and adjusts the transmit power of the downlink DPCH (i.e., the DPCCH and
5 DPDCH) at slot i (if possible).

For power control of the PDSCH, the user terminal also estimates the SNR of the transmission in slot i-1 of the PDSCH, and determines the TPC command corresponding to the estimated SNR. For the embodiment shown in FIG. 6 wherein multiple feedback substreams are formed with multiple TPC
10 fields, the user terminal sends the TPC command for the PDSCH in the TPC2 field in slot i-1 of the uplink DPCCH. Again, after the propagation delay, T_{pd} , the base station receives the uplink DPCCH, determines the TPC command in the TPC2 field of slot i-1, and adjusts the transmit power of the PDSCH at slot i (if possible). For an embodiment wherein the feedback substreams are formed
15 by time-sharing slots in the feedback stream, the user terminal may send the TPC command for the PDSCH in the TPC field in a subsequent slot of the uplink DPCCH (not shown in FIG. 6).

As indicated in FIG. 6, the received transmission is measured and power control information is generated and reported back as quickly as possible by
20 the user terminal. The base station similarly applies the power control as soon as possible (within one slot in many instances). The short delay improves the performance of the power control mechanism. If power adjustment within one slot is not possible (due to long propagation delay or uncertain time offset between the PDSCH and DPCCH), the base station can adjust the transmit
25 power at the nearest available slot.

The timing in FIG. 6 is typically dependent on various factors such as how the power control command is derived. If the other channels (PDSCH) include dedicated pilot bits, then the timing may be selected to minimize the feedback delay, which typically depends on the pilot bit position. In case of
30 PDSCH and if the techniques described in the aforementioned U.S Patent No. 6,097,972 or 5,903,554 are used, the measurement may be made on a common (continuous) pilot, and the timing may be derived backward so that the power control decision is completed just prior to when the uplink transmission bin is available.

FIG. 7 is a block diagram of an embodiment of base station 104, which is
35 capable of implementing certain aspects and embodiments of the invention. On the downlink, data for the DPCH and PDSCH for a particular user terminal

is received and processed (e.g., formatted, encoded) by a transmit (TX) data processor 712. The processing for the DPCH and PDSCH may be as described above in FIG. 2A, and the processing (e.g., encoding, covering, and so on) for each channel may be different from that of the other channel. The processed data is then provided to a modulator (MOD) 714 and further processed (e.g., covered, spread with short PN sequences, and scrambled with a long PN sequence assigned to the recipient user terminal). The modulated data is then provided to an RF TX unit 716 and conditioned (e.g., converted to one or more analog signals, amplified, filtered, and quadrature modulated) to generate a downlink signal. The downlink signal is routed through a duplexer (D) 722 and transmitted via an antenna 724 to the recipient user terminal.

FIG. 8 is a block diagram of an embodiment of user terminal 106. The downlink signal is received by an antenna 812, routed through a duplexer 814, and provided to an RF receiver unit 822. RF receiver unit 822 conditions (e.g., filters, amplifies, downconverts, and digitizes) the received signal and provides samples. A demodulator 824 receives and processes (e.g., despreads, decodes, and pilot demodulates) the samples to provide recovered symbols. Demodulator 824 may implement a rake receiver that processes multiple instances of the received signal and generates combined recovered symbols. A receive (RX) data processor 826 then decodes the recovered symbols for each transmission, checks the received frames, and provides the output data. Demodulator 824 and RX data processor 826 may be operated to process multiple transmissions received via multiple channels, such as the DPCH and PDSCH. The processing by demodulator 824 and RX data processor 826 may be as described above in FIG. 2B.

For downlink power control, the samples from RF receiver unit 822 may also be provided to an RX signal quality measurement unit 828 that estimates the SNR of the transmissions on the downlink DPCH and PDSCH. The SNR for each channel can be estimated using various techniques, such as those described in the aforementioned U.S. Patent Nos. 6,097,972, 5,903,554, 5,056,109, and 5,265,119.

The SNR estimates for the DPCH and PDSCH are provided to a power control processor 830, which compares the estimated SNR for each channel to the channel's setpoint, and generates the appropriate power control information (which may be in the form of TPC commands). The power control information for the DPCH and PDSCH is sent back to the base station via two power control feedback substreams.

Power control processor 830 may also receive other metrics for other channels being processed. For example, power control processor 830 may receive erasure indicator bits from RX data processor 826 for transmissions on the DPCH and PDSCH. For each frame period, RX data processor 826 may provide to power control processor 830 frame status (i.e., an indication whether the received frame is good or bad, or that no frame was received), QIB, or some other types of information. Power control processor 830 may then send the received information back to the base station.

On the uplink, data is processed (e.g., formatted, encoded) by a transmit (TX) data processor 842, further processed (e.g., covered, spread) by a modulator (MOD) 844, and conditioned (e.g., converted to analog signals, amplified, filtered, and quadrature modulated) by an RF TX unit 846 to generate a uplink signal. The power control information from power control processor 830 may be multiplexed with the processed data within modulator 844. The uplink signal is routed through duplexer 814 and transmitted via antenna 812 to one or more base stations 104.

Referring back to FIG. 7, the uplink signal is received by antenna 724, routed through duplexer 722, and provided to an RF receiver unit 728. RF receiver unit 728 conditions (e.g., downconverts, filters, and amplifies) the received signal and provides a conditioned uplink signal for each user terminal being received. A channel processor 730 receives and processes the conditioned signal for one user terminal to recover the transmitted data and power control information. A power control processor 740 receives the information (e.g., TPC commands, EIBs, QIBs, and so on, or a combination thereof) for the two feedback substreams and generates appropriate control signals used to adjust the transmit power for the DPCH and PDSCH.

Back in FIG. 8, power control processor 830 implements part of the inner and outer loops described above. For the inner loop of each independently power controlled channel, power control processor 830 receives the estimated SNR and sends back information (e.g., TPC commands) via the assigned feedback substream. For the outer loop, power control processor 830 receives the indication of good, bad, or no frame from data processor 826 and adjusts the setpoint for the channel accordingly. In FIG. 7, power control processor 740 also implements part of the power control loops described above. Power control processor 740 receives information on the feedback substreams and accordingly adjusts the transmit power of the transmissions on the DPCH and PDSCH.

The power control described herein can be implemented by various means. For example, power control can be implemented with hardware, software, or a combination thereof. For a hardware implementation, the elements in the power control can be implemented within one or more application specific integrated circuits (ASICs), digital signal processors (DSPs), programmable logic devices (PLDs), controllers, micro-controllers, microprocessors, other electronic units designed to perform the functions described herein, or a combination thereof.

For a software implementation, the elements in the power control can be implemented with modules (e.g., procedures, functions, and so on) that perform the functions described herein. The software code can be stored in a memory unit and executed by a processor (e.g., power control processor 740 or 830).

For clarity, various aspects, embodiments, and features of the multiple parallel feedback substreams have been specifically described for downlink power control. The techniques described herein may also be used for uplink power control. Also for clarity, various details of the multiple parallel feedback substreams have been described specifically for the W-CDMA standard. The techniques described herein may also be used to implement multiple parallel feedback substreams in other communication systems (e.g., other CDMA-based systems).

The foregoing description of the preferred embodiments is provided to enable any person skilled in the art to make or use the present invention. Various modifications to these embodiments will be readily apparent to those skilled in the art, and the generic principles defined herein may be applied to other embodiments without the use of the inventive faculty. Thus, the present invention is not intended to be limited to the embodiments shown herein but is to be accorded the widest scope consistent with the principles and novel features disclosed herein.

30

WHAT IS CLAIMED IS:

CLAIMS

1. In a wireless communication system, a method for supporting power control for a plurality of channels via a common feedback stream, comprising:
 - receiving a plurality of transmissions on the plurality of channels;
 - determining signal quality of the transmission received on each channel;
 - generating power control information for each channel based on the determined received signal quality for transmission received on the channel;
 - multiplexing power control information generated for the plurality of channels on a plurality of feedback substreams defined based on the feedback stream; and
 - transmitting the plurality of feedback substreams.
2. The method of claim 1, wherein each feedback substream is assigned to a respective channel to be independently power controlled.
3. The method of claim 1, wherein the feedback stream is formed by a power control field transmitted in a series of slots, with each slot corresponding to a particular time interval.
4. The method of claim 3, wherein the power control information generated for each feedback substream is transmitted in the power control field.
5. The method of claim 3, wherein each feedback substream is assigned to a respective set of slots.
6. The method of claim 5, wherein the slots assigned to the plurality of feedback substreams are selected based on a particular repeating pattern.
7. The method of claim 3, wherein two feedback substreams are defined.
8. The method of claim 7, wherein the slots assigned to the two feedback substreams are selected based on an "n-m" pattern, wherein n slots are assigned to a first feedback substream for every m slots assigned to a second feedback substream.

9. The method of claim 8, wherein the "n-m" pattern is either "1-1", "2-1",
2 "4-1", or "14-1".

10. The method of claim 1, wherein each feedback substream is
2 associated with a respective feedback rate, and wherein an aggregate feedback
rate for the plurality of feedback substreams is equal to or less than the
4 feedback rate of the feedback stream.

11. The method of claim 10, wherein two feedback substreams are
2 defined, wherein the feedback rate for a first feedback substream is 1000
command/second or greater, and wherein the feedback rate for a second
4 feedback substream is 500 command/second or less.

12. The method of claim 1, wherein the plurality of channels include a
2 dedicated channel and a shared channel.

13. The method of claim 12, wherein the plurality of feedback
2 substreams are utilized for feedback during time periods when the shared
channel is assigned for transmission, and wherein the feedback stream is
4 utilized for feedback during time periods when only the dedicated channel is
assigned.

14. The method of claim 12, wherein the feedback substream assigned to
2 the dedicated channel has a higher feedback rate than that of the feedback
substream assigned to the shared channel.

15. The method of claim 1, wherein the power control information
2 generated for at least one channel comprises power control bits indicative of
whether the received signal quality is above or below a target level.

16. The method of claim 1, wherein the power control information
2 generated for at least one channel comprises values indicative a received signal-
to-noise-plus-interference ratio.

17. The method of claim 1, wherein the wireless communication system
2 conforms to W-CDMA standard.

18. The method of claim 17, wherein the plurality of channels include a
2 downlink dedicated physical channel (downlink DPCH) and a physical
downlink shared channel (PDSCH).

19. In a W-CDMA communication system, a method for supporting
2 independent power control for two channels via a common feedback stream,
comprising:
4 receiving two transmissions on the two channels;
determining signal quality of the transmission received on each channel;
6 generating power control information for each channel based on the
determined received signal quality for transmission received on the channel;
8 multiplexing power control information generated for the two channels
onto first and second feedback substreams defined based on the feedback
10 stream, wherein the first feedback substream has a feedback rate of 1000
commands/second or greater and the second feedback substream has a
12 feedback rate of 500 commands/second or less; and
transmitting two feedback substreams.

20. In a wireless communication system, a method for supporting power
2 control for a plurality of channels via a plurality of feedback substreams,
comprising:
4 receiving a plurality of transmissions on the plurality of channels;
determining signal quality of the transmission received on each channel;
6 generating power control information for each channel based on the
determined received signal quality;
8 multiplexing power control information generated for the plurality of
channels on a plurality of feedback substreams, wherein each feedback
10 substream is defined by a respective field in each slot of a feedback subchannel;
and
12 transmitting the plurality of feedback substreams.

21. The method of claim 20, wherein the plurality of feedback
2 substreams have equal feedback rates.

22. The method of claim 20, wherein two feedback substreams are
2 defined by two fields in each slot.

23. The method of claim 22, wherein the two fields have equal number
2 of bits.

24. A power control unit for use in a wireless communication system,
2 comprising:
4 a signal quality measurement unit configured to receive and process a
4 plurality of transmissions on a plurality of channels to determine signal quality
of the transmission received on each channel; and
6 a power control processor coupled to the signal quality measurement
unit and configured to generate power control information for each channel
8 based on the determined received signal quality, and to multiplex power
control information generated for the plurality of channels onto a plurality of
10 feedback substreams defined based on a single feedback stream.

25. The power control unit of claim 24, wherein the plurality of feedback
2 substreams are assigned to respective sets of slots, with each slot corresponding
to a particular time interval.

26. The power control unit of claim 25, wherein two feedback
2 substreams are defined.

27. The power control unit of claim 26, wherein the slots assigned to the
2 two feedback substreams are selected based on an "n-m" pattern, wherein n
slots are assigned to a first feedback substream for every m slots assigned to a
4 second feedback substream

28. The power control unit of claim 27, wherein the first feedback
2 substream has a feedback rate of 1000 command/second or greater and the
second feedback substream has a feedback rate of 500 command/second or
4 less.

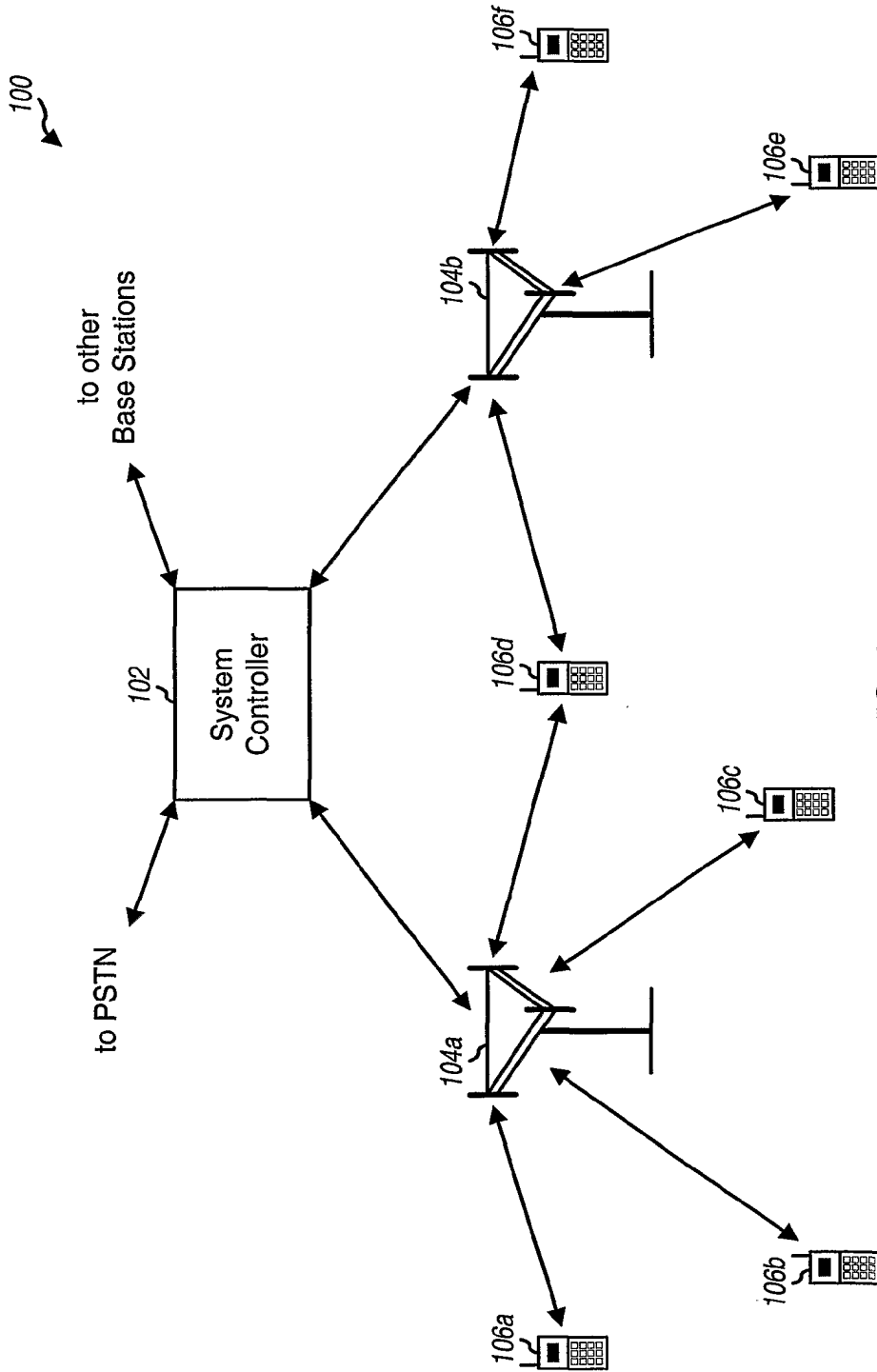

FIG. 1

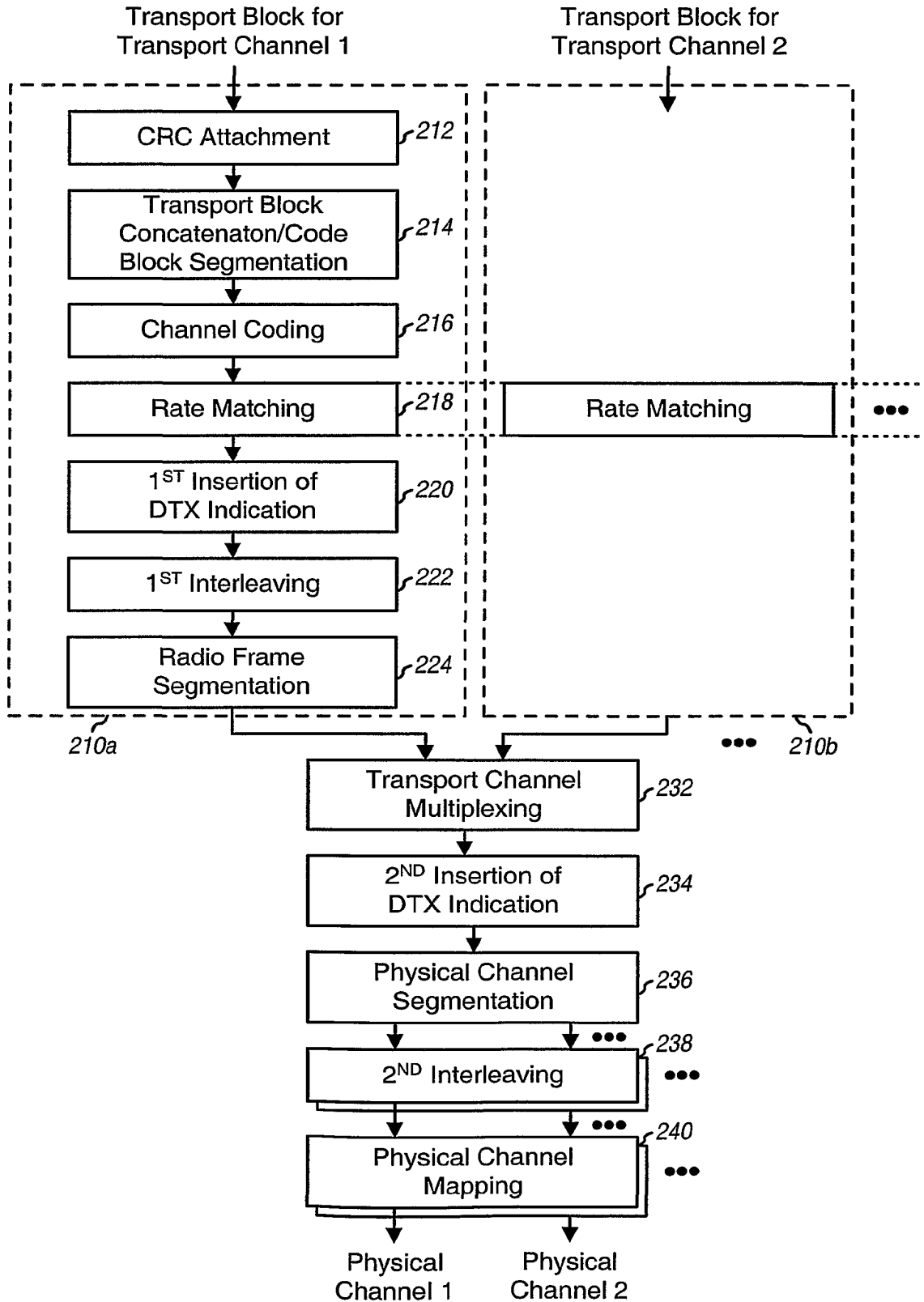

FIG. 2A

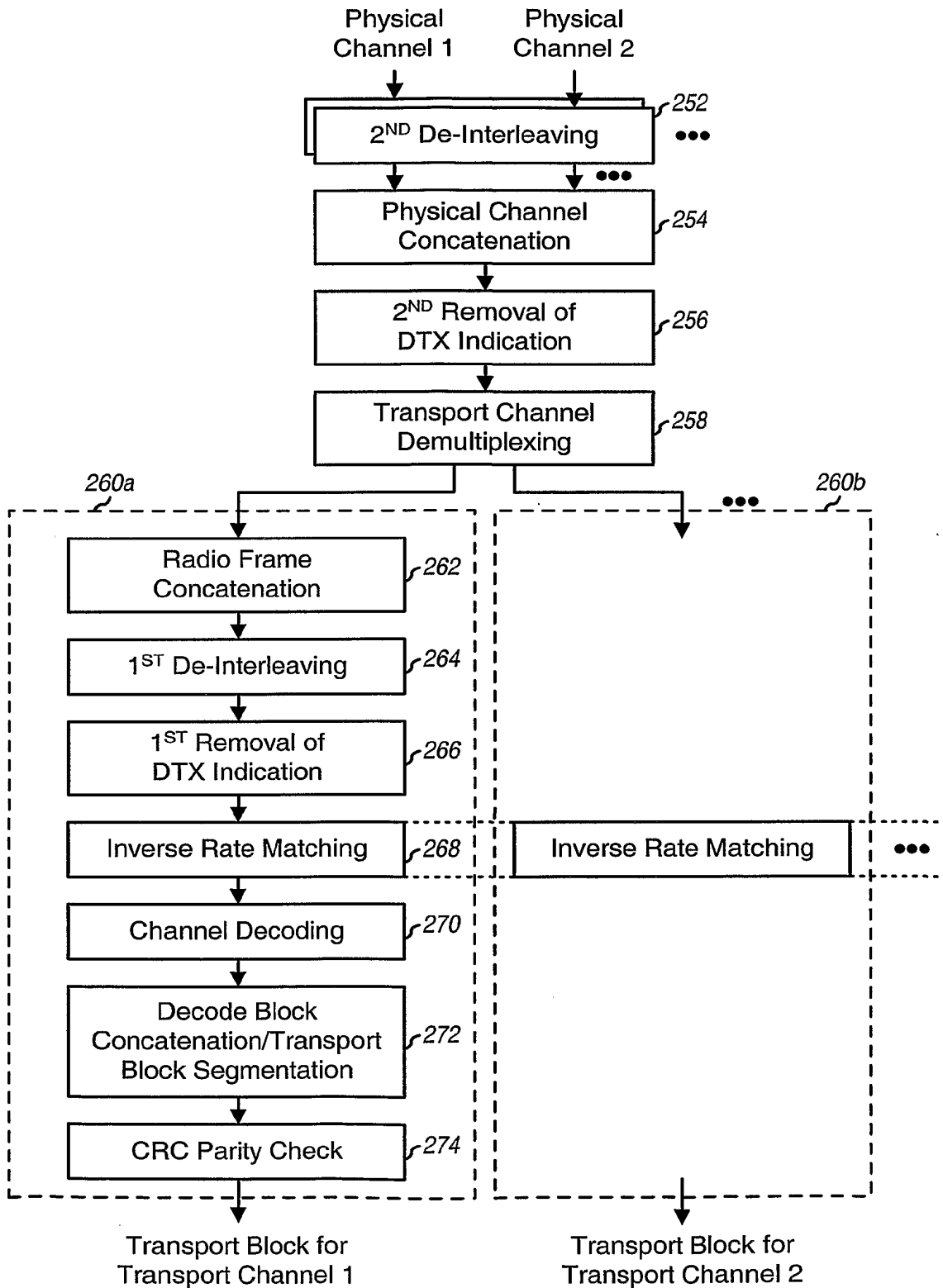

FIG. 2B

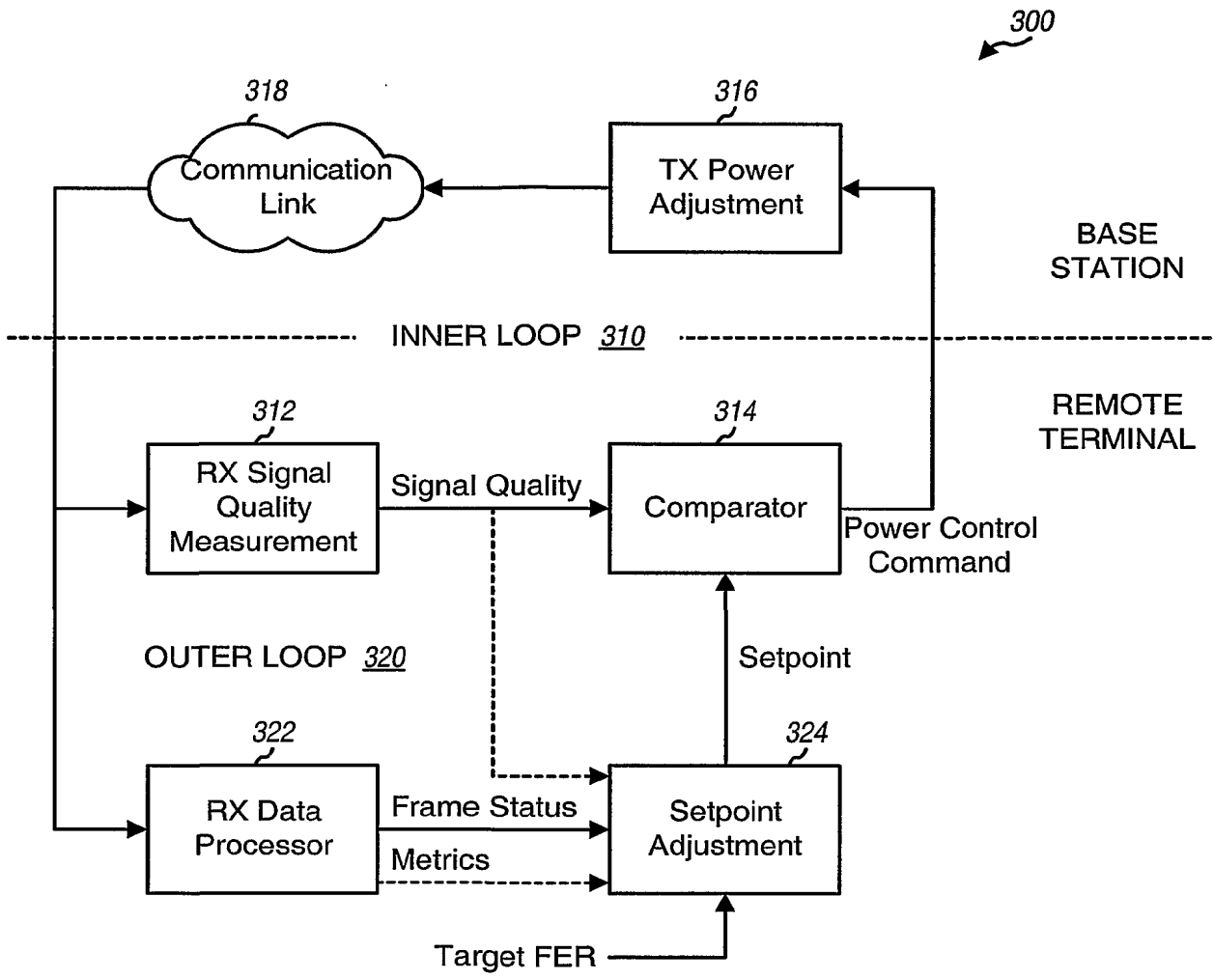

FIG. 3

410 ↗

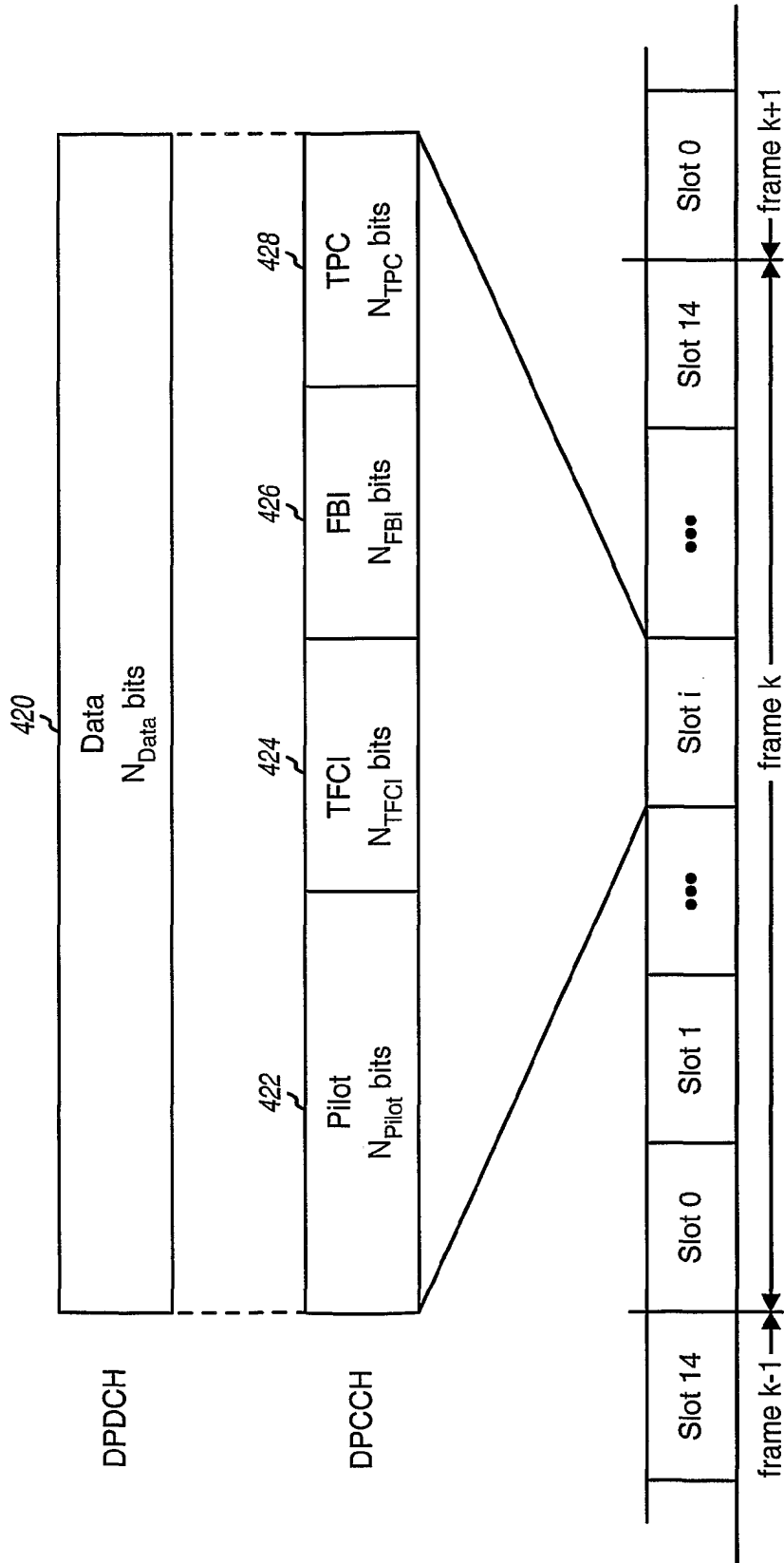

FIG. 4

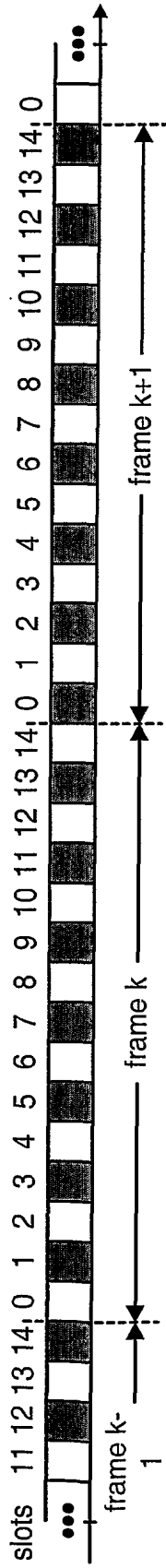
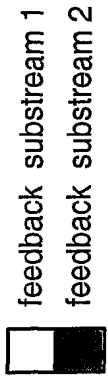

FIG. 5A

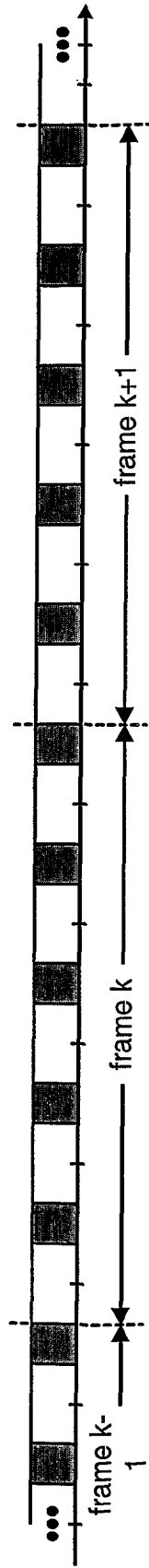

FIG. 5B

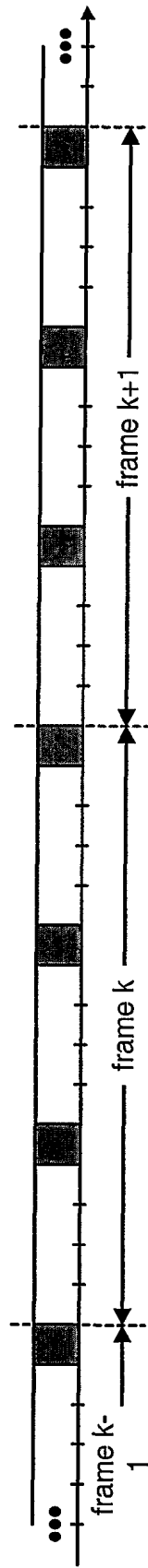

FIG. 5C

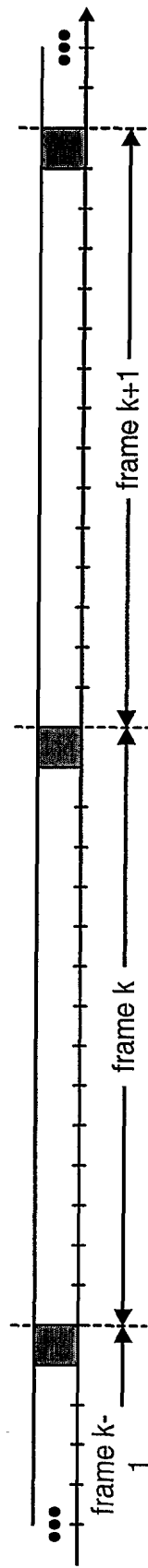

FIG. 5D

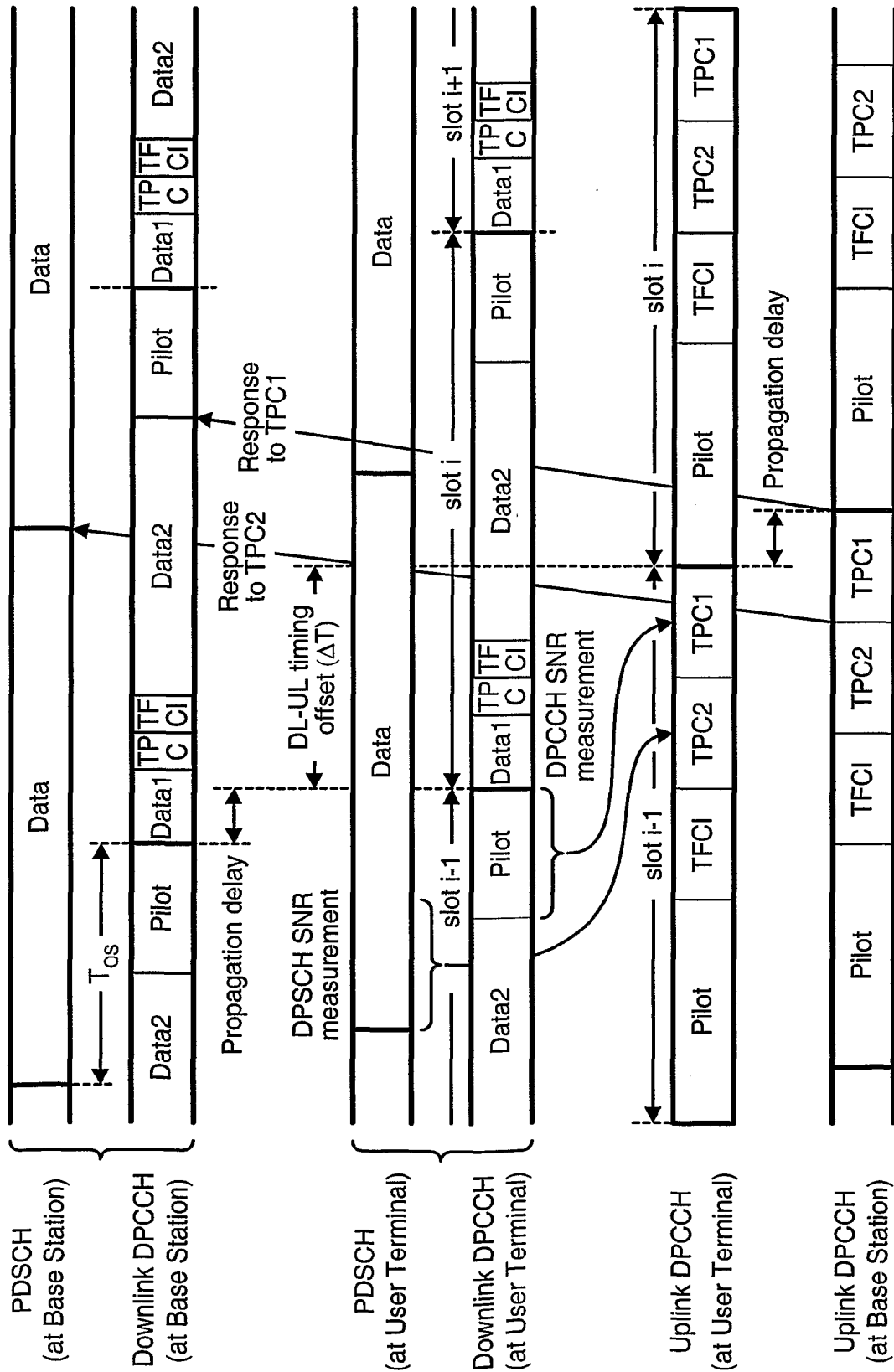

FIG. 6

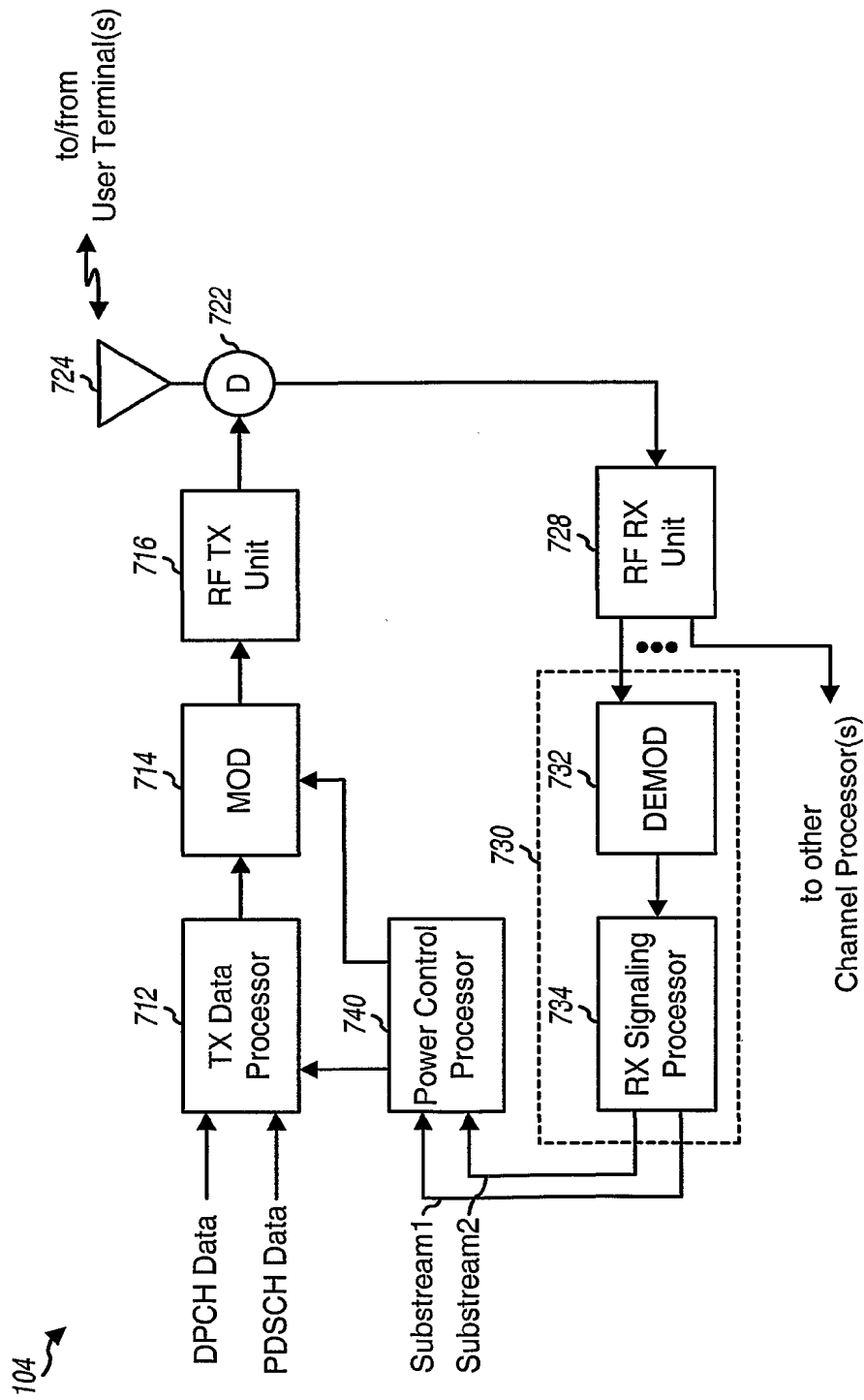

FIG. 7

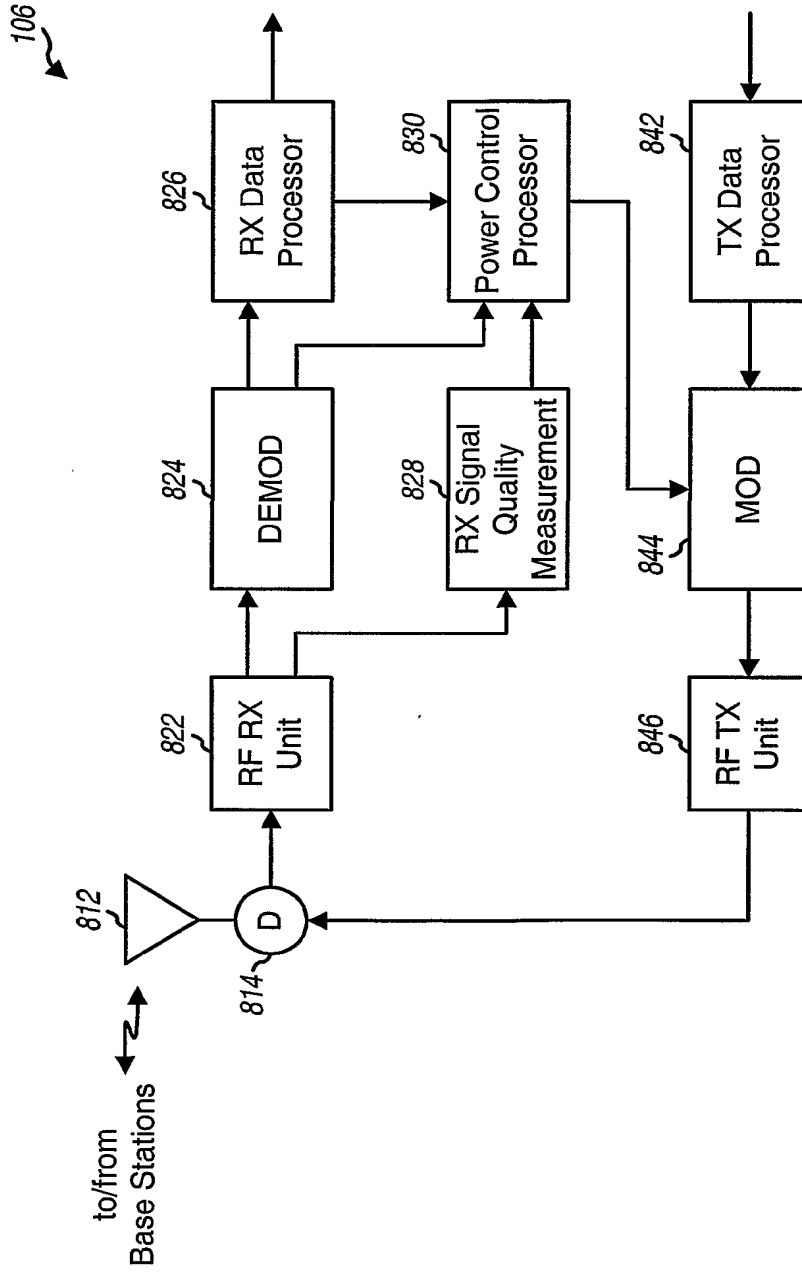

FIG. 8

INTERNATIONAL SEARCH REPORT

International Application No
PCT/US 02/04725

A. CLASSIFICATION OF SUBJECT MATTER
IPC 7 H04B7/005

According to International Patent Classification (IPC) or to both national classification and IPC

B. FIELDS SEARCHED

Minimum documentation searched (classification system followed by classification symbols)
IPC 7 H04B

Documentation searched other than minimum documentation to the extent that such documents are included in the fields searched

Electronic data base consulted during the international search (name of data base and, where practical, search terms used)
EPO-Internal, WPI Data, PAJ, INSPEC

C. DOCUMENTS CONSIDERED TO BE RELEVANT

Category °	Citation of document, with indication, where appropriate, of the relevant passages	Relevant to claim No.
A	WO 00 77948 A (NORTEL NETWORKS LTD) 21 December 2000 (2000-12-21) abstract page 4, line 10 -page 5, line 17 page 7, line 19 -page 8, line 34 page 11, line 19 -page 12, line 21 page 15, line 32 -page 16, line 11 ---	1, 19, 20, 24
A	EP 1 067 704 A (LUCENT TECHNOLOGIES INC) 10 January 2001 (2001-01-10) abstract column 1, line 28 -column 2, line 11 claim 6 ---	1, 19, 20, 24
A	US 6 173 162 B1 (JOHANSSON MATHIAS ET AL) 9 January 2001 (2001-01-09) abstract column 3, line 33 -column 4, line 27 ---	1, 19, 20, 24
	-/--	

Further documents are listed in the continuation of box C.

Patent family members are listed in annex.

° Special categories of cited documents :

- *A* document defining the general state of the art which is not considered to be of particular relevance
- *E* earlier document but published on or after the international filing date
- *L* document which may throw doubts on priority claim(s) or which is cited to establish the publication date of another citation or other special reason (as specified)
- *O* document referring to an oral disclosure, use, exhibition or other means
- *P* document published prior to the international filing date but later than the priority date claimed

- *T* later document published after the international filing date or priority date and not in conflict with the application but cited to understand the principle or theory underlying the invention
- *X* document of particular relevance; the claimed invention cannot be considered novel or cannot be considered to involve an inventive step when the document is taken alone
- *Y* document of particular relevance; the claimed invention cannot be considered to involve an inventive step when the document is combined with one or more other such documents, such combination being obvious to a person skilled in the art.
- *G* document member of the same patent family

Date of the actual completion of the international search

Date of mailing of the international search report

5 June 2002

11/06/2002

Name and mailing address of the ISA
European Patent Office, P.B. 5818 Patentlaan 2
NL - 2280 HV Rijswijk
Tel. (+31-70) 340-2040, Tx. 31 651 epo nl,
Fax: (+31-70) 340-3016

Authorized officer

Lustrini, D

INTERNATIONAL SEARCH REPORT

International Application No

PCT/US 02/04725

C.(Continuation) DOCUMENTS CONSIDERED TO BE RELEVANT

Category	Citation of document, with indication, where appropriate, of the relevant passages	Relevant to claim No.
A	EP 1 011 211 A (NIPPON TELEGRAPH & TELEPHONE) 21 June 2000 (2000-06-21) abstract paragraphs '0063!, '0081!, '0084! -----	1, 19, 20, 24

INTERNATIONAL SEARCH REPORT

 International Application No
 PCT/US 02/04725

Patent document cited in search report		Publication date	Patent family member(s)	Publication date
WO 0077948	A	21-12-2000	AU 4943500 A	02-01-2001
			AU 5096200 A	02-01-2001
			WO 0078069 A1	21-12-2000
			WO 0077948 A1	21-12-2000
EP 1067704	A	10-01-2001	US 6285886 B1	04-09-2001
			AU 4266300 A	11-01-2001
			BR 0003603 A	13-03-2001
			CN 1280425 A	17-01-2001
			EP 1067704 A2	10-01-2001
			JP 2001069077 A	16-03-2001
US 6173162	B1	09-01-2001	AU 746139 B2	18-04-2002
			AU 8050198 A	04-01-1999
			CN 1267410 T	20-09-2000
			EP 0990314 A1	05-04-2000
			JP 2002503427 T	29-01-2002
			WO 9858461 A1	23-12-1998
			TW 379486 B	11-01-2000
EP 1011211	A	21-06-2000	CN 1256823 T	14-06-2000
			EP 1011211 A1	21-06-2000
			WO 9847246 A1	22-10-1998